

Instruction Manual



dito

ESD Simulator
IEC 61000-4-2 / EN 61000-4-2

Manual to dito
(Version \geq 2.30)



EM TEST (Switzerland) GmbH

Sternenhofstrasse 15
4153 Reinach BL1
Switzerland

Phone : +41 61 717 91 91

Fax : +41 61 717 91 99

URL : <http://www.emtest.com>

Copyright © 2013 EM TEST (Switzerland) GmbH

All right reserved.
Specifications subject to change

Table of Contents

1.	Safety	5
1.1.	General	5
1.2.	Before Use	6
1.3.	Maintenance, Adjustments, Exchange of Parts	6
1.4.	Failures and Over stressing	7
1.5.	Danger during testing.....	7
1.5.1.	Power Mains Supply and Ground Reference.	7
1.5.2.	Discharge Modules and Grounding of <i>dito</i>	8
1.5.3.	Batteries and battery charger	9
1.5.4.	Danger from the Device Under Test (DUT)	9
2.	ESD test setup as per IEC 61000-4-2.....	10
2.1.	Test setup	10
2.2.	Parts and Connections of <i>dito</i>	11
2.3.	Parts and functions	12
3.	Operation and functions	13
3.1.	The Trigger Button	13
3.2.	The Menus	13
3.2.1.	Acoustical Signals	13
3.2.2.	Battery Condition	13
3.2.3.	Start-up Display	14
3.2.4.	Data Input to the Menus	14
3.3.	Main Menu	15
3.4.	Easy Zap Menu	15
3.5.	Quick ZAP	16
3.6.	Evaluation	17
3.7.	Test Routines	18
3.7.1.	Sequence of the iterations	18
3.7.2.	ESD test with Test Routines	19
3.8.	Setup menu.....	20
3.8.1.	Standard Levels	20
3.8.2.	Hardware settings	20
3.8.3.	Firmware setting	21
3.8.4.	System information	22
3.9.	Error messages.....	22
4.	Setting into operation.....	23
4.1.	General	23
5.	Technical data.....	24
5.1.	<i>dito</i>	24
5.2.	MAD mains Adapter.....	24
5.3.	Discharge modules	25
5.3.1.	As per IEC/EN 61000-4-2	25
5.3.2.	As per ISO 10605	25
5.4.	Test Routines	25
6.	Maintenance and practical advice	26
6.1.	General	26
6.2.	Calibration and Verification	26
6.2.1.	Factory calibration.....	26
6.2.2.	Guideline to determine the calibration period of EM Test instrumentation	26
6.2.3.	Calibration of Accessories made by passive components only	26
6.2.4.	Periodically In-house verification	26
6.3.	Verification	27
6.3.1.	Verification of the discharge parameters	27
6.3.2.	ESD waveform verification	28
6.4.	User calibration	30
6.5.	PowerPack dito Battery.....	30
6.6.	Battery charger	30

7.	Delivery	31
7.1.	Basic	31
7.2.	Options.....	31
8.	Annex	32
8.1.	CE-certificate of compliance	32
8.2.	General diagram <i>dito</i>	33
8.3.	General diagram <i>dito</i>	34
8.4.	Application	35
8.5.	Definitions	36

1. Safety

1.1. General

Read the following operations manual carefully. Pay special attention to both safety and operation details!!!

Observe all of these precautions to ensure your personal safety and to prevent damage to the test equipment of our product range.

The test generator is designed according to IEC 61010 respectively EN 61010.

Symbols



WARNING Risk of electrical shock. Please read the related paragraph in the operating manual.



GROUND At this point the 2m ground cable must be connected.

Power mains supply

The equipment is intended to be operated from a power mains supply that will not apply more than 250Vrms between the supply conductors or between either supply conductor and ground. A proper ground connection, through the grounding conductor in the power cord, is essential for a safe system operation. This is related to the use of the **dito** with the optional power mains adapter type **MAD**. Never apply a generator's voltage to a connector which is not specified for that voltage range.

Grounding ESD setup

ESD testing can be performed with battery- or mains-powered simulators. For reduce the risk of electrostatic discharge to the operator it is necessary to follow the rulers below:

- Use a proper grounding of the setup and ESD simulator
- Working as stated in the standard
- Follow the application guidelines in chapter 1.5.1 for a safe working

Grounding the generators

The generators are grounded through the power cord. To avoid electric shock, plug the power cord into a properly wired receptacle where earth ground has been verified by a qualified service person. Do this before making connections to the input or output terminals of the test equipment.

Also the 2m long grounding cable required by the IEC 61000-4-2 must be connected to the related grounding port (see under Symbols) while the test is running. Without the protective ground connection, all parts of generators are potential shock hazards. This includes knobs and controls that may appear to be insulators.

Use the Proper Power Cord

Use only the power cord and connector specified for your product. Use only a power cord that is in good condition.

Use the Proper Fuse

To avoid fire hazard, use only the fuse specified in the parts list for your product, matched by type, voltage rating and current rating.

Do Not Remove Covers or Panels

To avoid personal injury, do not operate the generators without the panels or covers.

Do Not Operate in Explosive Atmospheres

The generators provide no explosion protection from static discharges or arcing components. Do not operate them in an atmosphere of explosive gases.

Please read the attached operating manual carefully !!!



You will find some additional and product specific safety recommendations.

1.2. Before Use

Prior to power-on the equipment

- Before putting the instrument into operation, please check the equipment you have received for damage due to transportation. Check the single boxes as well as the generator itself for mechanical damage. In case of damages, please contact the manufacturer before switching on the unit.

Damage due to transportation

- Prior to applying power, check if the selected supply voltage complies with the mains:

115V/230V ??

- Equipment of security class I which is supplied by an auto-transformer may be considered as follows:

If the equipment is powered by an auto-transformer, with a primary voltage higher than the secondary voltage, be sure that the low-voltage end of the secondary part of the auto-transformer is connected with the neutral of the primary side.

Equipment of security class I with removable neutral or with mains plug:

It is only permitted to insert the mains plug in a mains socket with protective earth connector. It is not allowed to interrupt or disconnect the protective earth connection.

Performance of measurements

- Each interruption or disconnection of the protective earth connection inside or outside the equipment may lead to a dangerous situation. Intentional interruption is prohibited.
- Interconnections between such equipment or to others, e.g. for remote control by personal computer, may be done with cables recommended or delivered by the manufacturer.

1.3. Maintenance, Adjustments, Exchange of Parts

The generator does not include any parts or components needing special maintenance.

Electrical maintenance should only be performed by experienced, specially instructed technicians.

Generally, standard maintenance requires periodic cleaning of the instrument and verification and calibrations of the specified pulse parameters only.



Only trained technicians are allowed to perform service or maintenance work on these instruments.

- When removing the housing cover or other parts of the equipment, high voltage parts may become exposed. High voltage and high current are potentially lethal.
- The generator includes high voltage capacitors, which may retain their charge. **High voltage – High energy**
- For service, repair, adjustment, or replacement, the generator covers have to be removed and the generator must be disconnected from all power mains supplies.
- The user is not allowed to independently change or modify any EM TEST generator. For service and repair, only original EM TEST parts and components must be used. EM TEST is not responsible for any accident or injury incurred through the use of other parts or components.
- If maintenance or service work is necessary, it must be performed only by experts who are familiar with the existing danger.
- It has to be assured that only fuses of recommended type and nominal current are used for replacement. It is not permissible to use repaired fuses.

1.4. Failures and Over stressing

- If it is assumed that a safe operating mode of the equipment is no longer possible, the mains connection must be removed and the equipment secured from unintentional use.
- An unsafe operating mode is characterized as follows:
 - the equipment shows recognizable damages;
 - the equipment is not working;
 - the equipment has experienced severe transportation stress;
 - the equipment has been stored in an unsuitable environment for some time.

Please exercise prudence in determining whether a device is unsafe or not.

1.5. Danger during testing

ESD tests are immunity tests on electronic equipment or devices. These tests are potentially dangerous for the operator. Therefore it is the responsibility of the user to avoid critical failures and risks to the environment and operator.

Long and distributed lines to the EUT are able to radiate a certain energy to their vicinity. Therefore it is also the responsibility of the user to decide whether it is allowed to conduct immunity tests in a given installation.

Test voltages above 500V may generate spark discharges. Therefore it is forbidden to test in an explosive environment.

National and international recommendations regarding human safety must be followed.

People with certain health conditions, e.g. with a heart pacemaker or similar device, should be excluded from testing.

- When setting up the test, national and international regulations regarding human safety have to be guaranteed.

Handicapped people, e.g. persons using pacemakers, are not allowed to use this test instrumentation. Hazardous radiation may influence these products.

1.5.1. Power Mains Supply and Ground Reference.

- EMC and High Voltage test setups must have a good decoupled and stable power mains supply.
- Decoupling may be achieved by:
 - Filtering
 - The use of isolation transformers
- By the use of isolation transformers, ground current detectors will not work as intended anymore.
- EMC and High voltage test areas must include a clear ground reference strategy. All generators, CDN's and LISN's must be connected directly and as short as possible to the ground reference.
- The ground reference system must be connected to the Protective Earth (PE) connection of the laboratory.

1.5.2. Discharge Modules and Grounding of *dito*

- A discharge module includes capacitors as required in the related standard. The user must take into account that a capacitor is still charged. The charged energy is so low that there is no danger to life. The energy is lower as required in standard IEC 61010.
- During the test, the discharge tip is at high voltage potential. Touching the discharge tip during a running test may cause uncomfortable discharges to the operator. Due to the low energy there is no danger to life.



Risk of electrical shock. Do not touch any metallic part at the discharge module.
The 2m grounding cable must always be connected to the *dito* during any operation.
Do not discharge the simulator into the air, because electrostatic charge can discharge and shock the operator.

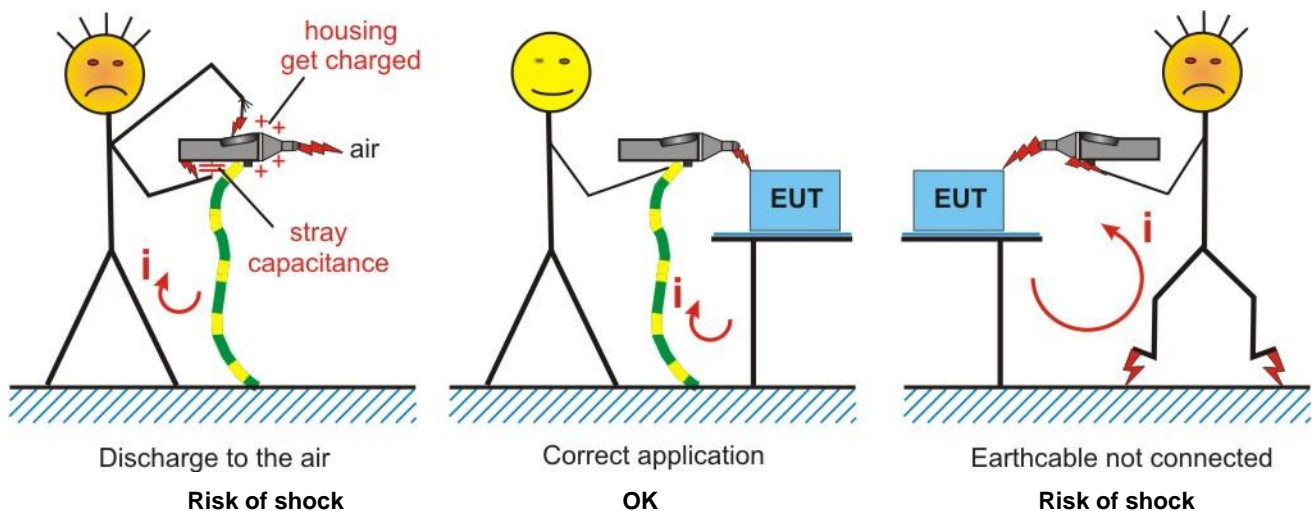

Remarks to the correct application with ESD generators.

Earth cable not connected

The 2m grounding cable, which is required by the standards, must always be connected between **ESD simulator** and the ground reference system. In case that the grounding cable is not connected, the discharge current of the simulator will flow through the body of the operator and may cause uncomfortable discharges.

Discharge to the air

When discharge the ESD simulator to the air, all not grounded parts are charged and keep the charged load. When touch the housing after such event it can happen that people are discharge the charged parts and get an electrical shock up to some kilovolts.

Between the *ditto* and the hand surface is a stray capacitance. When the operator discharge an ESD impulse into the air the stray capacitance generates a potential between the discharge module and the operator. The effect is a discharge to the operator with return through the earthcable to the **ESD simulator**.

1.5.3. Batteries and battery charger

- Do not charge dry batteries. There is a danger of explosion.
- For charge the rechargeable LiFePO4 **PowerPack dito** use only the **CU dito** charger.
- The use of the old charger ACH may destroy the **PowerPack dito**.
- Do not open the charger. Repairs must only be done by the manufacturer.

Environment:

Batteries are hazardous waste. Put used batteries into a special container or bring them to a special recycling center.

1.5.4. Danger from the Device Under Test (DUT)

The DUT may become dangerous due to the applied high voltage or to the energy content of the test pulses.



Therefore, please pay attention to the following points during testing:

- As soon as the DUT ceases to operate as intended, the test must be stopped immediately.
- In the case of internal damage, high voltages might be exposed at any point of the DUT.
- Cables and connectors can be overloaded by high voltages or energies.
- Due to internal damage of components, explosion and fire may occur.
- Unintended use of the DUT may cause hazardous situations in the vicinity of the test setup.

**Never touch the DUT or anything connected to the DUT
While running a test.**

2. ESD test setup as per IEC 61000-4-2

2.1. Test setup

A correct test set-up is very important for a reproducible test procedure, especially for ESD testing. The correct test set-up as specified in the standard is mandatory. Some of the most important points are the following:

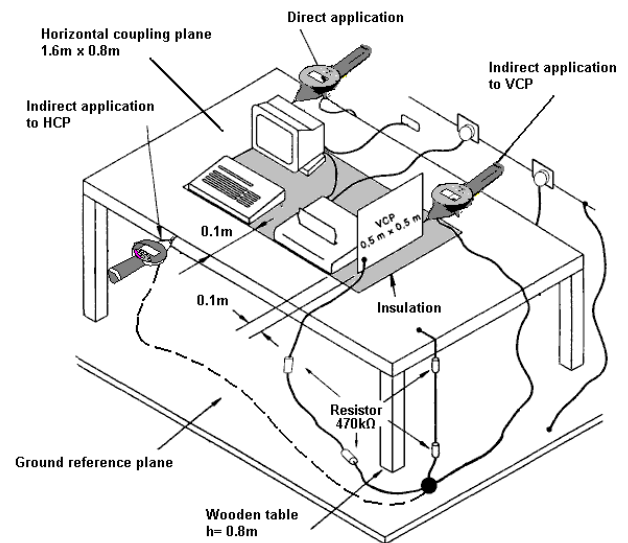

1. Test table

The test must be performed on a wooden test table. On the table, a metallic plane of at least 1.6x0.8m must be used, the so-called horizontal coupling plane HCP. The EUT has to be isolated by 0.5mm from this metallic plane.

2. Ground reference plane

The ground reference plane is located under the test table. It must exceed the projection of the horizontal coupling plane by at least 0.5m on all sides and must be connected to the protective grounding system.

The horizontal coupling plane on the test table has to be connected to the ground reference plane by 2x470 kΩ resistors (EAS30).

3. Test generator

The test generator must be properly connected to the ground reference plane.

Important: The ESD simulator must not be connected to the horizontal coupling plane.

The discharge unit 2m ground cable must be connected to the ground reference plane and not to the horizontal coupling plane.

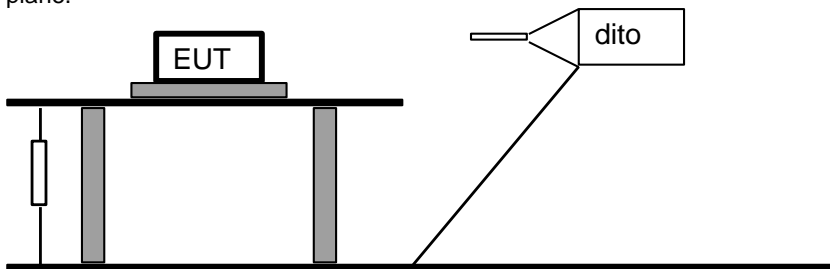

2.2. Parts and Connections of *dito*

The following figure shows all possible connections to *dito*.

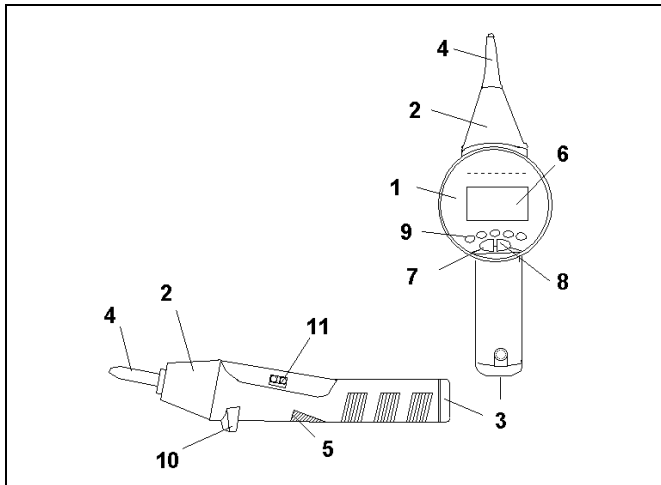

Connections to *dito*

Parts

- 1 dito base unit
- 2 Discharge Module
- 3 Battery
- 4 Discharge Tip

Operation

- 5 Trigger and ON/OFF
- 6 Display
- 7 - Button
- 8 + Button
- 9 Function keys F1...F5

Connections

- 10 Ground Cable
- 11 Optical Interface

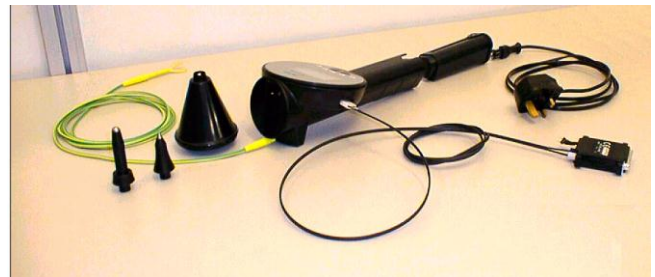

The 2m grounding cable

- Connect the grounding cable to the reference ground connector of dito.
- Grounding is also possible at the screw terminal for tripod mounting.

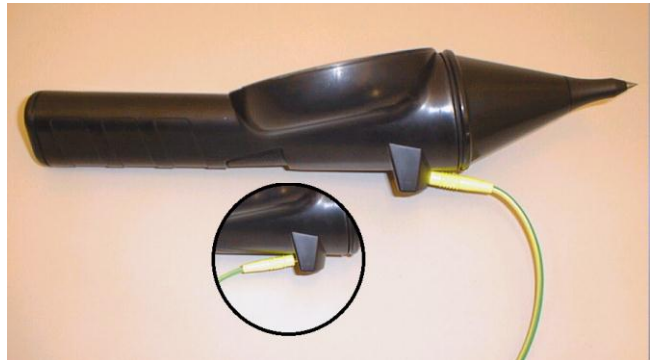

2.3. Parts and functions



dito,
Simulator for discharges of Static Electricity.

Discharge tips

- Contact discharge
- Air discharge

Discharge module with RC parameters

DM1 C= 150pF, R=330Ω

DM2 C= 330pF, R=2000Ω

DM3 C= 150pF, R=2000Ω

DM4 C= 100pF, R=500Ω

Power Pack dito

LiFePO₄ accu battery module

CU ditto

battery charger for PowerPack dito

MAD

Mains adapter to operate **dito** from AC power mains

Carrying case

Grounding cable

EAS 30

Grounding resistor

esd.control

Software for up/down load procedures, remote control of **dito**, test reports and including type IFA interface adapter; optical link to USB

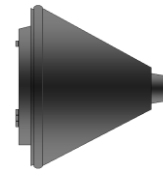
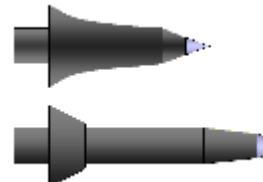



3. Operation and functions

3.1. The Trigger Button



The following functions are activated with the **Trigger** button:

To switch ON	Press the Trigger button once
To switch OFF	Press the Trigger button for 3s Exception (dito is in Start Mode)
To change the menus	Press the Trigger button once
To release discharges	Single: Press Trigger button once Cont : Discharging as long as the Trigger button is pressed. Auto: Press Trigger button once, the test runs automatically. Pressing Trigger button again stops the test procedure.

3.2. The Menus

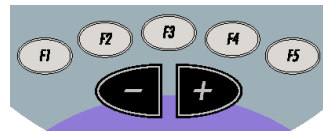
dito is operated with the help of an easy to use menu structure, based on 5 function keys , the  and the **Trigger** button.





Functions	The desired functions are selected with the 5 function keys. The selected function is blinking. The displayed value is always related to the actual selected parameter.
Change	Functions, which are related to fixed parameters, are changed by multiple pressing of the related function key, e.g. Trigger mode: Single-Cont-Auto
Numerical parameters	Numerical parameters are changed using the  . First the parameter is changed in 1 digit steps. After 10 steps without pause the parameter will be increased by 10 digit steps for example 12,13,14,15,16,17,18,19,20,21,22, 32,42 ... 112 ,212... With a short pause in between pressing the  the 1 digit steps will be continued: 1,2,3,4,5,6, Pause <0.5s , 7,8,9,10,11,12,13,14,15,16,17, 27,37 ...
Confirm parameter	The correct input is confirmed by pressing the Trigger button or another function key .

3.2.1. Acoustical Signals

Single-beep	- Input confirmation if key Beep is ON - Indicates that dito is ready for a new air discharge. e.g. for rep=5s a single beep will be generated 5s after the previous discharge
Double-beep	A double beep always indicates warnings or failures. <ul style="list-style-type: none"> - No or wrong discharge Module - No discharge relays available - Test voltage not reached or not correct - Pre-discharge (air discharge occurred before the selected test voltage was reached) - Battery voltage too low to generate high voltage.
Triple-beep	- Test is finished - dito has shut down (switched OFF)

3.2.2. Battery Condition

The battery symbol shows the actual condition of the battery.

	100%-80%	Battery is charged
	10% - 0%	Battery is discharged, HV generation is disabled

3.2.3. Start-up Display

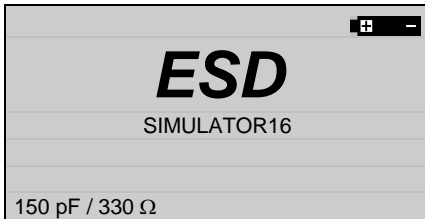

After switching ON, **dito** starts a self test routine to check the basic function of the unit including the high voltage power supply. The R/C discharge parameters of the module are displayed in the lower line.

In case that there is no discharge module connected, **dito** will show the message **No Discharge Module**.

In case that there is any problem **dito** displays a failure message.

3.2.4. Data Input to the Menus





Mode	AD : Air Discharge CD : Contact discharge Change Mode by pressing the Mode button F2 more than once
Trigger	Single : Single discharges after pressing the Trigger button. Cont : Continuous discharges as long as the Trigger button is pressed Auto : Automatic released discharges, Start/Stop by Trigger button Change Trigger by pressing the Trigger button F3 more than once
Count	The counter has two basic functions: Count = 1...999'990↑ : dito counts the total number of discharges Count = 1...30000↓ dito tests a preselected nbr of discharges Change Count by pressing Count button F5 and select with
Rep/Freq	Repetition rate General : 0.5...20s in 0.5s steps Evaluation : 1...20 Hz in 1Hz steps (max. 10Hz for CD) Change Rep by pressing Rep/ Freq and select with
Voltage	Input of the test voltage ULevel 500V ..16.5kV (depends on hardware in 100V steps) UStep 100V...9900V Change Voltage by pressing Start and the Up / Down buttons
High voltage	STOP in inverse letters indicate the running test. The high voltage is applied to the discharge module.
Polarity	Change by pressing Start and using Changing the polarity during a test, will take 1...5 seconds depending on the voltage level.
Test point	Number of test points at different discharge modes; AD and CD

3.3. Main Menu

Main Menu	
F1	Easy Zap
F2	Quick Zap
F3	Evaluation
F4	Test Routines
F5	Setup

Easy ZAP

Easy Zap is based on "Standard Test Levels". After pressing "Start", the operator can select the required test level with F1 to F5  and with  the polarity can be changed.

Quick ZAP

Within Quick Zap the test voltage can be changed while running a test. With the buttons  the polarity can be changed. The value ΔU per step can be selected in the *Service Menu* under *Setting*.

Evaluation

This test routine helps to search for most sensitive test points at the DUT. The discharges are released with a higher repetition rate. This routine is normally not used for final testing at the preselected test points.

Test Routines

The *dito* includes 8 test routines, which the operator can program on his own by using the esd.control software. The data can be downloaded via the optical interface. The test routines will guide the user through the complete test procedure.

Setup

Hardware and software settings are made in this menu.

- Standard test levels for AD and CD can be set.
- Hardware settings
- Firmware settings
- System information

3.4. Easy Zap Menu

Easy ZAP is used for fast and easy testing on fixed test level basis.

Easy ZAP		
+	15.0kV	Auto
		1.0 s
AD	Level 4	10↓
	Mode	Rep
Start	Trigger	Count

Before the test is started, the operator has to select

- the discharge mode, contact discharge **CD** or air discharge **AD**
- the trigger mode, **Single – Continuous – Automatic**
Preferred modes are Single & Auto
- the **Repetition** rate of the discharges
- the number of discharges **Count**

After pressing **Start**, the menu shows up as follows: Start / Stop of the test with the trigger button

dito is ready for testing ← Triggerbutton → **dito is charged**

Easy ZAP		
+	15.0kV	Auto
		1.0 s
AD	Level 4	10↓
	Level	
Stop	1	2 3 4

F1	F2	F3	F4	F5
----	----	----	----	----

Easy ZAP		
+	15.0kV	Auto
		1.0 s
AD	Level 4	10↓
14850 V	Level	
Stop	1	2 3 4

F1	F2	F3	F4	F5
----	----	----	----	----

During the test, you can change polarity by pressing buttons . The actual generated discharge voltage is displayed. In case of AD, it may happen that the discharge occurs before the final voltage level is reached. The message **Pre-discharge** is shown in the display.

With the function keys F2...F5, the operator can change the test level.

Pressing the function key F1 will stop the test routine.
For change standard parameters refer to chapter 3.8.1.

3.5. Quick ZAP

In **Quick ZAP**, the test voltage can be increased/decreased by ΔU during the test. The ΔU value can be specified in the *Service Menu* under *Setting*.

Quick ZAP		⊕ -
+	8.0kV	Auto
		1.0 s
AD	Level 3	10 ↓
Mode	Rep	
Start	Trigger	Count

Before the test is started the operator has to select

- the discharge mode, contact discharge **CD** or air discharge **AD**
- the trigger mode, **Single – Continuous – Automatic** (Preferred mode are Single & Auto)
- the **repetition** rate of the discharges
- the number **Count** of the discharges

After pressing **Start**, the menu shows up as follows: **Start / Stop** of the test with the trigger button

dito is ready for testing ← Triggerbutton → **dito is charged**

	Voltage	
Stop	Down	Up

8020 V	Voltage	
Stop	Down	Up

F1	F2	F3	F4	F5
----	----	----	----	----

F1	F2	F3	F4	F5
----	----	----	----	----

During the test, you can **change polarity** by pressing buttons . With the function buttons F2/F3 (Down), the test voltage will decrease and with F4/F5 (Up), the test voltage will increase.

The actual generated discharge voltage is displayed. In case of AD, it may happen that the discharge occurs before the final voltage level is reached. The message **Pre-discharge** is shown in the display.

Pressing the function key F1 will stop the test routine.

For change voltage step parameter refer to chapter 3.8.3.

3.6. Evaluation

This menu can be used to check the DUT for most sensitive test points. The preferred method to find these test points is air discharge.

Air discharges are continuously generated with a maximum repetition rate of 20Hz.

Contact mode is selected for long duration tests to apply a large number of repeatable discharges to a specified test point. The preferred Trigger mode is Auto or Continuous.

All parameters can be selected individually. During the evaluation procedure, the operator can change the polarity and the test voltage.

Evaluation		
+	8.0kV	Cont
AD	Level 3	10.0 Hz
		12↑
Mode	Freq	
Start	Trigger	Count

Input range for the frequency: Remark: The repetition frequency can be different to the set value. The reason is a longer charging time caused by lower battery voltage

AD : 1Hz....20Hz
 CD : 1Hz....10Hz
 Step : 1Hz

After pressing **Start**, the menu displays: **Start / Stop** of the test with the trigger button

dito is ready for testing ← Trigger button → **dito is charged**

Voltage					8020 V Voltage				
Stop	Down	Up			Stop	Down	Up		
F1	F2	F3	F4	F5	F1	F2	F3	F4	F5

The ΔU steps can be preselected in the menu *Setup / Program Setting / dU Step* . See the previous paragraph.

Display of the charging voltage during a test

8020 V	Voltage				-----	Voltage			
Stop	Down	Up			Stop	Down	Up		

During **Evaluation** testing with AD Module the charging voltage depends from the distance of the arc between the test finger and EUT.

While moving dito across the EUT manually, the distance is not stable and the discharges occur at different charging voltage level. **dito** gives some information at which voltage ranges the generator was discharged.

8020 V	Voltage	The generator was discharged at the selected test voltage of e.g. 8kV
----- V	Voltage	The generator was discharged before the selected test voltage of e.g. 8kV was reached. The Discharge happens before the charging voltage is reached. The discharge tip is too close to the EUT when the discharge happened.
Voltage to low		The ESD generator can not be charged to the selected test voltage. May be the discharge tip is in direct contact or too close to the EUT.

The normal display during a "Evaluation" testing with a AD Module is " - - - - - ".

3.7. Test Routines

Dito saves up to 8 test routines, which are created by the **esd.control** software and transferred to **dito**. **dito** guides the user through the test and indicate every point for testing.

Any EUT fail can be marked by Fail1 or Fail2 with a comment in the test notes. After the test, the data can be uploaded to the computer to create a final test report

Test Routine 1			Test Routine 2		
F1	EN 61000-6-1	AD	F1	ISO 10605	AD
F2	EN 61000-6-1	CD	F2	ISO 10605	CD
F3	EN 61000-6-2	AD	F3		
F4	EN 61000-6-2	CD	F4		
F5	Page 2		F5	Page 1	

Select the desired test routine. To select more test routines press F5 Page 2.

Display after a test routine selection

Testname			
+ -	L1	2.0 kV	Auto
	L2	4.0 kV	1.0 s
CD	L3		10 ↓
±PV	L4		3 TP
Start	TP	Change	

Menu Change

Trigger	Rep	Count

The following parameters are new in this menu:

L1...L4 Levels of the selected test routines. Undefined test levels are marked with no voltage display.

+ - Both polarities are tested

±PV Automatic test sequence, see next paragraph

TP Number of EUT test points. **dito** will test every test point with every test level.

The parameter trigger, repetition, counter as well as the number of test point can be changed. All other parameters are fix within the related test routine.

3.7.1. Sequence of the iterations

The sequence, in which the parameter polarity, test level and test point are handled, can be defined in 3 different modes.

±PV Select the 1st test point and the starting test level. First the polarity (±) is changed, then go to the next test point (P) and finally repeat with the increased test level (V) .

±VP Select the 1st test point and the starting test level. First the polarity (±) is changed, then the test level (V) is increased and finally go to the next test point (P).

V±P Select the 1st test point and the starting test level. First the test level (V) is increased, then the polarity (±) is changed and finally go to the next test point (P)

3.7.2. ESD test with Test Routines

1. Press the **Start** button for run the test procedure.

dito shows the position of the actual test point for testing by a blinking TP 1. This means, the tester must start with testing the test point 1.

After 10 discharges **dito** shows in the display a blinking TP2 to continue testing the next test point.

dito will guide the user through the test.

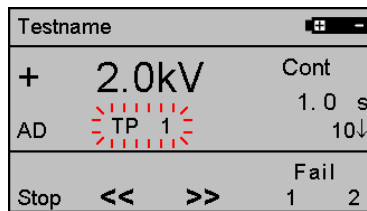

2. Begin with discharging at **Test point 1**. The discharge starts with pressing the **trigger** button.
3. Events as **Fail 1, Fail 2, Next** must be documented by writing a comment in the test notes (created with the **esd.control** software.

Stop	The running test is stopped .
<< (Redo)	Repeat the test at the actual test point. Fail1 or Fail 2 information will be deleted and the test level is set back to the starting level.
>> (Next)	Change to the next test point or test level. dito shows on his display as example : Report Break : Nr
Fail 1	Fail 1 (The criteria for this fail must be defined by the user)
Fail 2	Fail 2 (The criteria for this fail must be defined by the user)

If you want to print the test notes please make indicate informations about the abnormal reaction of the EUT.

4. Terminate the test with the **Stop** button or **dito** stops automatic after the last discharge on the last test point.
5. Note the displayed **Date** and **Time** in your test notes.

End of the test

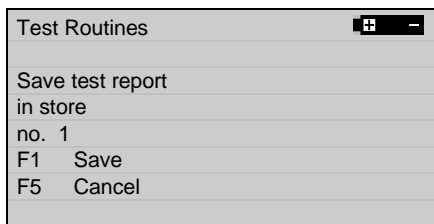

dito saves all tests with a number 1...20 as reference.

Using **esd.control** you find the test referenced by the test name and this number.

Report memory in ditto

dito has the internal capability to save 20 files with results of test routines. A full memory is displayed at the begin of a test as shown below.

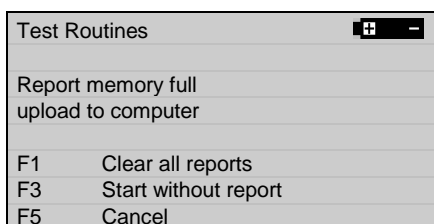

The following procedures are possible for continue:

- F1 Clear all reports** in **dito**. The removed files can not be transferred later to the computer.
- F3 Start without report**. During the test no data are saved. Please use a test notes for having a document.
- F5 Cancel** and transfer the data with the software **esd.control** to the computer. Erase with **esd.control** the test report you don't need in the future.

3.8. Setup menu

Service	
F1	Standard Level
F2	Hardware Settings
F3	Firmware Settings
F4	System Information



3.8.1. Standard Levels

The standard voltage levels can be modified within this menu. The parameters are entered separately for air discharge and contact discharge.

Standard Levels		
F1	Mode AD	
F2	Level 1	2.0 kV
F3	Level 2	4.0 kV
F4	Level 3	8.0 kV
F5	Level 4	15.0 kV
-	Reset to default	

F1	Mode CD	
F2	Level 1	2.0 kV
F3	Level 2	4.0 kV
F4	Level 3	6.0 kV
F5	Level 4	8.0 kV
-	Reset to default	

To change the Standard Level:

F1	Toggles between AD and CD Level input
F2...F5	Press the buttons   for the setting of the voltage levels.
-	(if indicated 2 s keep long pressed) the indicated standard level resets to following factory setting
Trigger button	Back to the Setup Menu

Test level requirements as per IEC 61000-4-2

Contact Discharge		Air Discharge	
Test Level	Test voltage [kV]	Test Level	Test voltage [kV]
1	2	1	2
2	4	2	4
3	6	3	8
4	8	4	15
x	special	x	special

Test sequence :

- Minimum 10 discharges positive and negative
- Starting at the lowest test level
- Repetition rate max. 1 discharge/sec



3.8.2. Hardware settings

Hardware Setting		
F1	Key Beep	OFF
F2	Contrast	- / +
F3	Baudrate	9600

Key Beeper

The beeper indicates that that a button is pressed. This function can be switched off. Also, see the beeper specification in paragraph. 3.2.1

Contrast

The contrast of the display can be select with F2 and adjusted with the keys  

Baud rate

The baud rate can be specified as 4800, 9600, 19200 Baud. Use the key F3 for selection.

Default settings

Key Beep : OFF
Baudrate : 9600

3.8.3. Firmware setting

Firmware settings	
F1 ΔV Step	1.0 kV
F2 Vr/ Vlevel	80 %
F3 Vr/ Vlevel	OFF
F4 AD Timer	OFF
F5 Pre Discharge	OFF

ΔV Step

Selection of the voltage/step (ΔV) parameter which is used in the menus **Quick ZAP** and **Evaluation**. Range 100V...9900V. Default setting 1000V.

Vr/ V level discharge detection

After each discharge the residual voltage **Vr** within **dito** is measured. Due to the **Vr/ Vlevel** ratio **dito** knows if a discharge occurred. Based on this parameter the operator can decide whether a discharge is accepted as a complete discharge or not.

In case of **NO discharge** a double beep will be generated. It is up to the user to decide on this discharge. The counter will decrease in each case

REMARK: For a discharge detection, a voltage drop of approx. 200V is necessary. Slow voltage changes as RC discharges of the module and recharge for voltage stabilization, will not trip the discharge detection. Isolated EUT with small surface or already charged parts generates a small voltage drop who will not detect as discharge. This effect happens more at lower test levels.

Range for Vr 20...80 , (10% step), minimum voltage is 2000V

This function can only be used for CD mode and AD mode when the rep rate is larger than 0.5s. In the case when the discharge frequency is higher than 2Hz, it cannot be guaranteed that the test voltage ever reaches the preselected value. The discharge voltage mostly is determined by the distance of the spark gap.

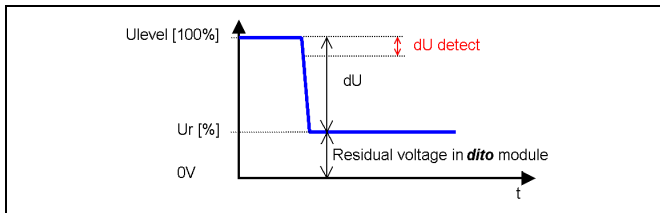

Vlevel = Test voltage

Vr = Residual voltage remaining at the discharge tip after a discharge occurs

Vdetect = min. voltage drop for discharge detection

Calculated value for $dV = V \text{ level} - Vr$

Warning Ur/U level ON / OFF

In case that **dito** is not discharged completely, an acoustic warning signal will appear. This may happen during testing of insulated objects. Maybe the EUT was charged up due to the previous testing so that no more discharges can be made to the EUT. Maybe only small partial discharges occur which may not be detected as a spark over by the operator. The function **Vr/Vlevel** can be used as spark over sensitivity detection.

AD Timer

Beep for release of next AD discharge. The AD timer is only an acoustic beep to indicate that the time between two pulses is over and has no influence to the test procedure. The user must release the next pulse himself.

The AD timer starts after the pulse detection and deliver a Beep after the selected repetition time. At any time it is possible to start with the next pulse.

Pre Discharge ON / OFF

A discharge by AD testing caused by a too short distance during the charging procedure will indicate a double beep with the display Pre-Discharge. The counter will not count this discharge.

Default settings

ΔU Step :	1.0kV
Ur/Ulevel :	80%
Ur/Ulevel :	OFF
AD Timer :	OFF

3.8.4. System information

The user can not change the system information.

System Information	
Type	: Simulator
Version	: V 2.00
Dev. Nr	: dito700046

The serial-number and the version-number is necessary to guarantee full traceability of the instrument. These numbers also are listed in the test report, which is generated within esd.control.

3.9. Error messages

Pre-Discharge

The discharge occurs before **dito** reached the charging voltage. Therefore the applied voltage is out of the tolerance. The discharge tip is too near to the EUT.

Help: Increase the distance from the discharge dip to the EUT. (Approach fast to the EUT)

Voltage too low

The discharge tip has a direct contact to the EUT or the distance to the EUT is too low. Therefore it is not possible to charge the discharge module.

Help: Increase the distance from the discharge tip to the EUT. (Approach fast to the EUT).

No Discharge-Module

No discharge module is connected to the **dito**.

No Discharge Relays

The connected discharge module has no relays built in for contact discharge. Replace the discharge module.

Battery voltage too low for high voltage

The Battery voltage is too low. **dito** is not able to charge to the selected test voltage

Help: Charge or replace the battery .

4. Setting into operation

4.1. General

- The ESD test is an EMC test. This means that artificial interference, which may lead to malfunction of electronic equipment, is generated. As consequence, the operator has the responsibility to avoid any risk for persons and material during laboratory tests. Long connection cables of the DUT can radiate certain energy and interfere with adjacent devices that do not belong to the test setup. Therefore, it is also the responsibility of the operator to decide whether EMC-tests are permissible in a certain environment and, if so, on what premises.
- National and international safety standards must be taken into account during each test procedure.
- Operators must be well educated in the use of high voltage test instruments.
- The discharge module must be connected to the ground reference plane during operation.
- The user is not allowed to change or modify any part of the instrument by himself. For service and repair, only original EM TEST parts or components must be used. EM TEST is not responsible for damage or personnel hazard due to the use of different parts or components.
- If maintenance or service work is necessary, it may be performed only by experts who are familiar with the existing danger.
- In case of using a tripod to mount the dito for longterm testing, the power mains adapter MAD shall be used
 - to achieve similar ground reference conditions as during handheld testing
 - to avoid running out of battery supply during automated test procedures

5. Technical data

5.1. dito

Test voltage	Contact discharge (CD) 500V to 10kV Air discharge (AD) 500V to 16.5kV	
Resolution	In 100V steps	
Tolerance	±5% at the discharge tip	
Polarity	Positive, negative, alternating	
Trigger mode		
Single	Single discharge by pressing the trigger	
Continuous	Continuous discharges as long as the trigger is pressed	
Auto	Automatic discharges for tripod setup	
External	Via optical link and esd.control	
Counter		
Count down	1 ... 30'000	
Count up	0 ... 999'999	
Operating mode		
Manual	Via function keys of <i>dito</i>	
Remote control	Via optical interface and RS 232 adapter (option)	
Display	LCD; graphical display with 128x64 pixel	
Supply		
Battery mode	Continuous operation for >70000 discharges at 16.5kV (LiFePO4)	
Save mode	Auto-Switch-Off after 10 minutes without any operation	
Battery voltage	12.8V / 1000 mAh	
Self discharge	3 – 5% /month	
Charging cycles	> 1000	
Connector	Lemo part number : FFA.0S.304.CLA37	
Weight	180g	
Housing	Not flammable as per ABS-UL94V0	
General data		
Temperature range	15 – 35°C (59 to 95°F)	As per IEC 61000-4-2
Relative humidity	30 – 60% non condensing	As per IEC 61000-4-2
atm. pressure	86 kPa (860 mbar) to 106 kPa (1 060 mbar)	As per IEC 61000-4-2
Total weight	app. 870g	

5.2. MAD mains Adapter

Supply voltage	90V – 264V , 50Hz-60Hz
Power	5VA
Fuse	500mA TT
Weight	215g
Pin connection	1 : nc 2 : Power GND 3 : Power + polarity 4 : nc

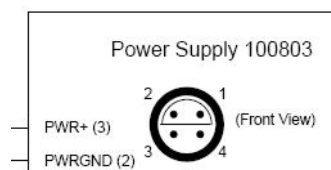

5.3. Discharge modules

5.3.1. As per IEC/EN 61000-4-2

Test voltage	AD : 1 – 16.5kV and CD: 0.5 - 10kV
Discharge capacitor	150pF \pm 10%
Discharge resistor	330 Ω \pm 10%
Holding time for AD	\geq 5s

Test voltage	2kV	4kV	6kV	8kV
tr rise time	0.7-1.0 ns	0.7-1.0 ns	0.7-1.0 ns	0.7-1.0 ns
Ipeak	7.5A \pm 10%	15.0A \pm 10%	22.5A \pm 10%	30.0A \pm 10%
\hat{I} at 30 ns	4.0A \pm 30%	8.0A \pm 30%	12.0A \pm 30%	16.0A \pm 30%
\hat{I} at 60 ns	2.0A \pm 30%	4.0A \pm 30%	6.0A \pm 30%	8.0A \pm 30%

5.3.2. As per ISO 10605

Test voltage	AD : 1 – 16.5kV and CD: 0.5 - 10kV	
Discharge capacitor	150pF \pm 10%	330pF \pm 10%
Discharge resistor	2000 Ω \pm 10%	2000 Ω \pm 10%
Holding time	\geq 5s	
Discharge mode	AD or CD	

Test voltage	2kV	4kV	6kV	8kV
tr rise time	0.7-1.0 ns	0.7-1.0 ns	0.7-1.0 ns	0.7-1.0 ns
Ipeak	7.5A \pm 10%	15.0A \pm 10%	22.5A \pm 10%	30.0A \pm 10%

Other R/C discharge networks are available on request.

The discharge modules are equipped with two different discharge tips:

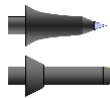

Sharp tip \angle 30° for contact discharge (CD)

8mm round tip for air discharge (AD)

5.4. Test Routines

Easy Zap	Fixed test level based test routine. Very fast and easy to handle. Fast check of the DUT. Fixed standard test levels; polarity, number of discharges and the repetition rate can be preselected.
Quick Zap	Very fast and easy to handle test routine. While the test is running, the test voltage and the polarity can be selected. All other parameters can be preselected before the test is started.
Evaluation	Fast test routine to determine the most sensitive test points at the DUT. Prior before a standard test routine is used.
Test Routines	Level 1 to 4 as per IEC/EN 61000-4-2 and per Generic Standard EN 50082-1 and -2. Test points can be preselected. User guided test procedure. All data can be used for test reporting in esd.control software.

< Specifications subject to change without notice >

6. Maintenance and practical advice

6.1. General

dito is maintenance free.

6.2. Calibration and Verification

6.2.1. Factory calibration

Every EM TEST generator is entirely checked and calibrated as per International Standard regulations before delivery. A calibration certificate is issued and delivered along with a list of the equipment used for the calibration proving the traceability of the measuring equipment. All auxiliary equipment and accessories are checked to our internal manufacturer guidelines.

The calibration certificate and the certificate of compliance (if available) show the date of calibration.

The EM Test equipment are calibrated in the factory and marked with a calibration mark. The used measuring instruments are traceable to the Swiss Federal Office of Metrology.

The calibration date is marked. The validity of the calibration is to the responsibility of the user's quality system. Neither the certificate of calibration nor the corresponding label mark any due date for re-calibration.



Example: Calibration mark

6.2.2. Guideline to determine the calibration period of EM Test instrumentation

Our International Service Departments and our QA Manager are frequently asked about the calibration interval of EM TEST equipment.

EM TEST doesn't know each customer's Quality Assurance Policy nor do we know how often the equipment is used and what kind of tests are performed during the life cycle of a test equipment. Only the customer knows all the details and therefore the customer needs to specify the calibration interval for his test equipment.

In reply to all these questions we like to approach this issue as follows :

EM TEST make use of a solid state semiconductor switch technique to generate high voltage transients. A precious advantage of this technique is the absolute lack of periodical maintenance effort. In consequence thereof a useful calibration period has to be defined based on two criteria :

- The first one is the customer's Quality Assurance Policy. Any existent internal regulation has to be applied at highest priority. In the absence of such internal regulation the utilization rate of the test equipment has to be taken into consideration.
- Based on the experience and observation collected over the years **EM TEST recommend a calibration interval of 1 year** for frequently used equipment. A 2-years calibration interval is considered sufficient for rarely used test generators in order to assure proper performance and compliance to the standard specifications.

6.2.3. Calibration of Accessories made by passive components only

Passive components do not change their technical specification during storage. Consequently the measured values and the plots stay valid throughout the storage time. The date of shipment shall be considered as the date of calibration.

6.2.4. Periodically In-house verification

Please refer to the corresponding standard before carrying out a calibration or verification. The standard describes the procedure, the tolerances and the necessary auxiliary means. Suitable calibration adapters are needed. To compare the verification results, EM Test suggests to refer to the wave shape and values of the original calibration certificate.

6.3. Verification

- For the calibration procedure, an adequate measuring set-up must be used. The directions given in the chapter "Verification of the characteristics of the ESD generator" of the IEC 61000-4-2 standard have to be strictly followed. Only expert laboratories with adequate knowledge or EM Test or its authorized distributors are permitted to perform calibration of dito.

Verification set-up according IEC-61000-4-2

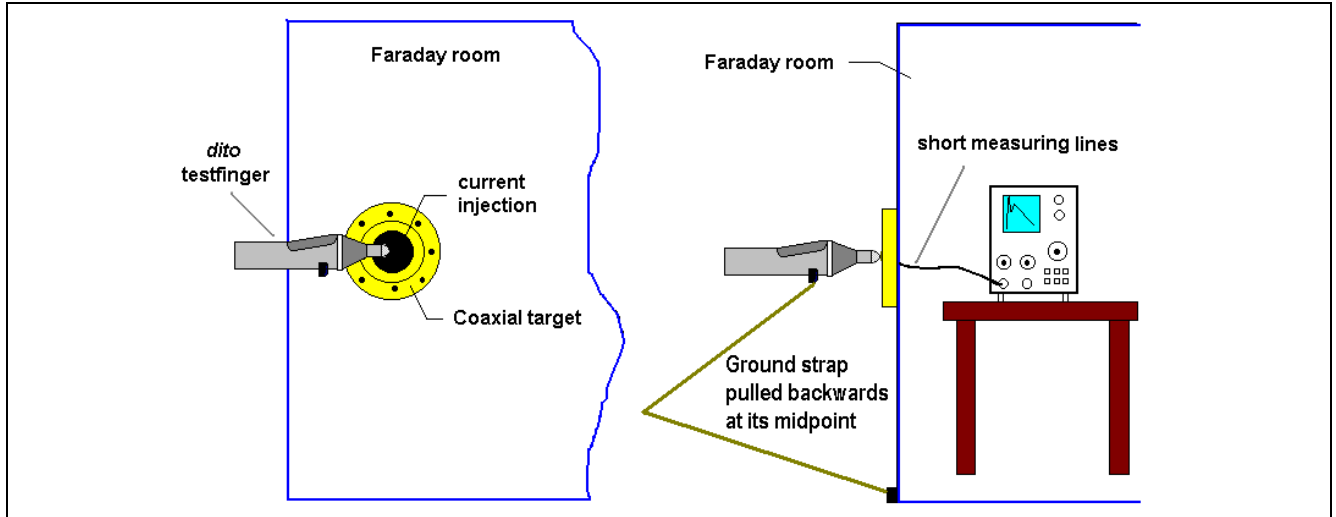

It is very important to keep the loop of the ground cable as large as possible as shown in the upper figure.

6.3.1. Verification of the discharge parameters

The verification is specified for contact discharge mode only.

Verification procedure:

- Preselect **Easy ZAP**, Mode = **CD**, Trigger = **Single**
- Select the test level and press the **Start** key
- Contact the discharge tip to the surface of the calibration shunt.
- Press the Trigger button and one single discharge will be released.

Specification as per IEC 61000-4-2:

Test level	I _{peak}	I at 30ns	I at 60ns	Rise time
	±10%	±30%	±30%	
2000V	7.5 A	4.0A	2.0A	
4000V	15.0A	8.0A	4.0A	0.7-1.0 ns
6000V	22.5A	12.0A	6.0A	
8000V	30.0A	16.0A	8.0A	

In case of using a tripod for mounting the dito, the power mains adapter (MAD) shall be used. This is to realise similar ground reference conditions as with the dito held in the operators hand.

6.3.2. ESD waveform verification

EM TEST recommends the following test equipment:

- Digital oscilloscope with at least 2GHz single shot bandwidth
- Faraday cage
- EM TEST CTR-2 Coaxial Target including 20dB attenuator and high quality coaxial cable

Capturing the waveform on the scope can only be achieved with the proper setup on the Digital Oscilloscope (DSO). The setup must be chosen to measure waveforms at ± 2KV, ± 4KV, ± 6KV and ± 8KV. There are five measurements required for each voltage.

- Initial peak current
- Risetime at 10% to 90% of initial peak current
- Current level at 30ns
- Current level at 60ns

The time domain for the initial peak and rise time measurement is 1ns/Div and 10ns/Div for the measurement of the current at 30ns and 60ns.

Below shows typical waveforms at 4KV:

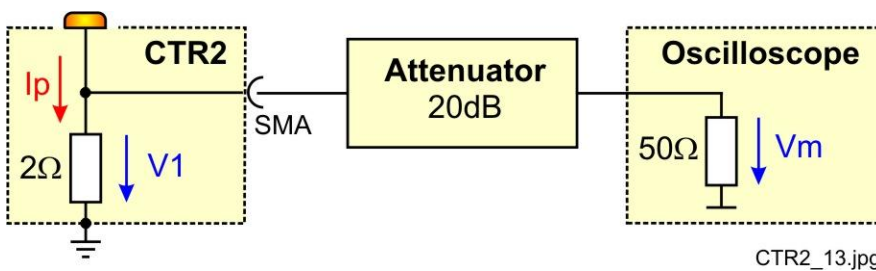
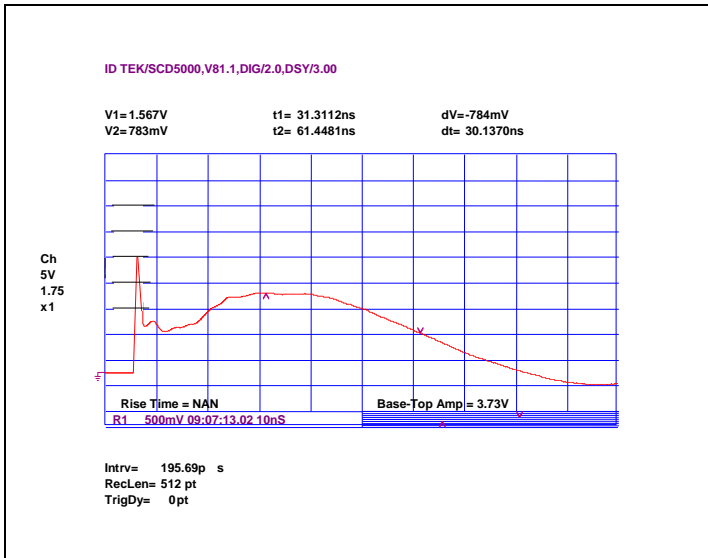

$V1 = 20dB \times Vm$
 $V1 = 2\Omega \times I1$
 $\rightarrow Ip = 20dB \times Vm / 2\Omega$

$Vm =$ displayed measuring voltage [V]
 $V1 =$ measured voltage across the 2Ω target
 $Ip =$ discharge current

$Ip = 5 \times Vm$



A discharge current of 7.5A therefore will result in a displayed $Vm = 1.5V$

Example of a calibration certificate

DIN EN ISO/IEC 17025



CALIBRATION CERTIFICATE

EM Test (Switzerland) GmbH, Sternenhofstrasse 15, CH- 4153 Reinach, www.emtest.com

Certificate No	CE-1211112234-569911-Dito		
Order No	KD-999999	Date of Order	06.03.2012
Operator	P. Fuchs	Date of Calibration	21.03.2012
Customer	Name of the customer. City, Country		
Object	ESD Generator		
Type	Dito		
Serial No	V1211112233	Inventory No	- - -
Firmware Version	2.31	Device	212023
Modules	150pF / 330Ω	Serial No	1602
	150pF / 330Ω RFCI	Serial No	1601
Manufacturer	EM Test (Switzerland) GmbH		
Remarks			

The instrument has been fully tested and calibrated. It complies with the following standards and with the manufacturers specification.

- IEC 61000-4 part 2. Ed.2. : 2008
- ISO 10605 : 2008

Calibration Results

The reported expanded uncertainty of measurement is stated as the standard uncertainty of measurement multiplied by the coverage factor $k = 2$, which for a normal distribution corresponds to a coverage probability of approximately 95%.

The measurement uncertainty is not taken in account for determining compliance with the specifications.

Traceability

This calibration certificate documents the traceability to national standards, which realize the physical units of measurements (SI).

The measurements, the uncertainties with confidence probability and calibration methods are given on the following pages and are part of the certificate. The document CMAM000001D is used as base for the accredited calibration procedure.

Calibration Intervals of the calibrated equipment

The equipment should be re-calibrated at appropriate intervals.

Calibration Intervals of EM Test Measuring equipment

According to our accredited management system all used measuring equipment of EM Test is calibrated in cycles of two years.

Copies of the Certificate

This calibration certificate shall not be reproduced except in full, without written approval of the laboratory EM Test.

Certificates of EM Test are not valid without signature of the head of the laboratory.

Date	Head of the Calibration Laboratory	Name
------	------------------------------------	------

Dito

This report must not be reproduced except in full

Page 1 of 5

6.4. User calibration

NOTE: This feature will be implemented in the future

This procedure may be used if any discrepancies occur during a calibration in external calibration laboratories. This means there are differences between the factory setting and the **measured** values in the lab.

With the help of this menu the operator can match the measured parameters into the tolerance of the standard.

The operator can vary the factory setting for the high voltage generation within a certain range. For both polarities the offset and the gain can be adjusted. See the following figures.

With F1 the user calibration can be enabled. The offset and gain range can be adjusted using the plus and minus buttons on the front panel.

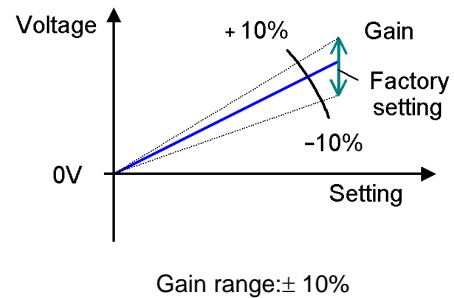
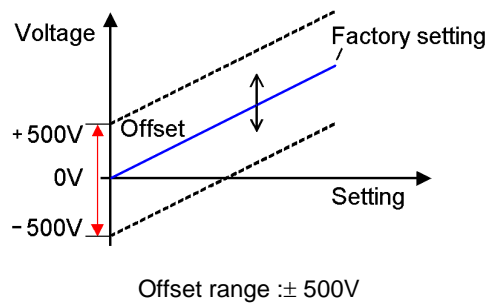

6.5. PowerPack dito Battery

- Shorting the batteries must be strictly avoided.
- The batteries must only be charged with the original EM TEST battery charger model CU dito
- Old LiFePO4 accu must be recycled
- Integrated protection for low undervoltages

Pin configuration:

- 1 Power + polarity
- 2 Power GND – polarity
- 3 nc
- 4 Sense

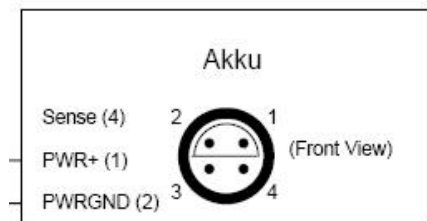

6.6. Battery charger

The charger is designed for quick charge of LiFePO₄ batteries.

- Large input range 100V – 240V.
- Battery charging time of only approx. 2 hours
- Battery charge before starting the charging cycle is of no importance

Operation:

The charger starts charging automatically after the battery pack is installed and the charger is plugged in.

During the correct charging cycle, the red LED is always on.

The charging is finished when the LED turns green.

Technical data

Series PCs	4S 12V3-5AH
Rated output	14.6V at no load
Output Range	CC (Current: 0.5 A, 10<14.4 V) – CV(14.4 – 14.6 V, C decreasing until 80 mA)
Rated current	500mA
Max Output Power	7.3W
Input	100V – 240V AC 50/60Hz
Ambient	Temp -10 - +40 °C
Humidity	< 90%

LED

- Red Charging cycle
- Green Battery fully charged/no load

7. Delivery

7.1. Basic

- **dito** ESD generator
- 1 discharge module included (e.g. 150 pF / 330 Ohm)
- Discharge tip for air discharge (8mm round)
- Discharge tip for contact discharge (sharp \angle 30°)
- LiFePO4 battery
- Grounding cable (2 m)
- Battery charger
- Carrying case
- Manual
- Certificate of compliance

Identical accessory parts are delivered only once if several devices are ordered. The delivered packing list is in each case valid for the delivery.

7.2. Options

Discharge modules

DM 1	C= 150pF, R=330 Ω	according IEC 61000-4-2
DM 2	C= 150pF, R=2000 Ω	according ISO TR10605
DM 3	C= 330pF, R=2000 Ω	according ISO TR10605
DM 4	C= 100pF, R=1500 Ω	according MIL
DM X	customized modules on request	
	C = 50pF to 500pF and R = 10 Ω to 10k Ω	

MAD Mains Adapter to operate from AC power
alternative to battery operation 85 – 265 V; 50-60 Hz
power consumption < 30VA

PowerPack dito Spare battery (LiFePO₄)

CU dito battery charger for PowerPack dito

esd.control Operating software with optical interface **dito** – computer

EAS 30 Earthing resistor 2x470k Ω to test table, 1.40m

VCP Vertical coupling plane Set for indirect testing.

Optolink Fiber optic link and interface for dito and ESD 30N with USB A connector, length 3m

CTR 2 Target 2 Ohm for verification

CTR 2 target



- Operating software with optical interface **dito** – computer
 - Test, analysis and documentation with windows
 - License version for testing according the most industrial standards
 - Report generator with export function to word-processing software

See manual esd.control software



8. Annex**8.1. CE-certificate of compliance****DECLARATION OF CONFORMITY**

Manufacturer : **EM TEST (Switzerland) GmbH**
 Address: Sternenhofstr. 15
 CH 4153 Reinach
 Switzerland

declares, that under its sole responsibility, the product listed below, including all options, are conform with the applicable CE directives listed below, using the relevant section of the following EC standards and other normative documents.

Product name: dito
 Model Function Simulator for Electrostatic Discharge

Low Voltage Directive 2006/95/EC

Standard to which conformity is declared:

EN 61010-1 : 2006 Safety requirements for electrical equipment for measurement, control, and laboratory use.

EMC Directive 2004/108/EG

Standard(s) to which conformity is declared:

EN 61326 : 2006 Electrical equipment for measurement, control and laboratory use Class A
 EN 61000-3-2 : 2007 Limits for harmonic current emissions
 EN 61000-3-3 : 2005 Limitation of voltage changes, voltage fluctuations and flicker in public low-voltage supply systems.

European representative
 EM TEST GmbH
 Lünenerstr. 211
 D 59174 Kamen
 Tel: +49 (0) 2307 / 26070-0
 Fax: +49 (0)2307 / 17050



Manufacturer
 EM TEST (Switzerland) GmbH
 Sternenhofstr. 15
 CH 4153 Reinach
 Tel: +41 61-7179191
 Fax: +41 61-7179199



By	U. Flor General manager	A. Burger Design and Research
Place	Kamen, Germany	Reinach BL , Switzerland
Date	05.December 2011	05.December 2011

8.2. General diagram *dito*

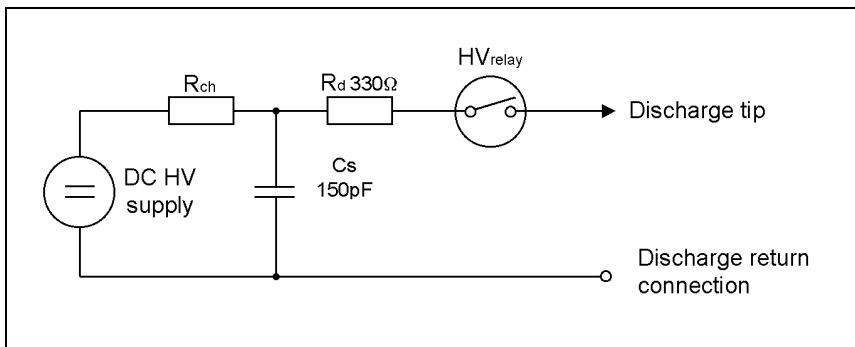

8.3. General diagram *dito*

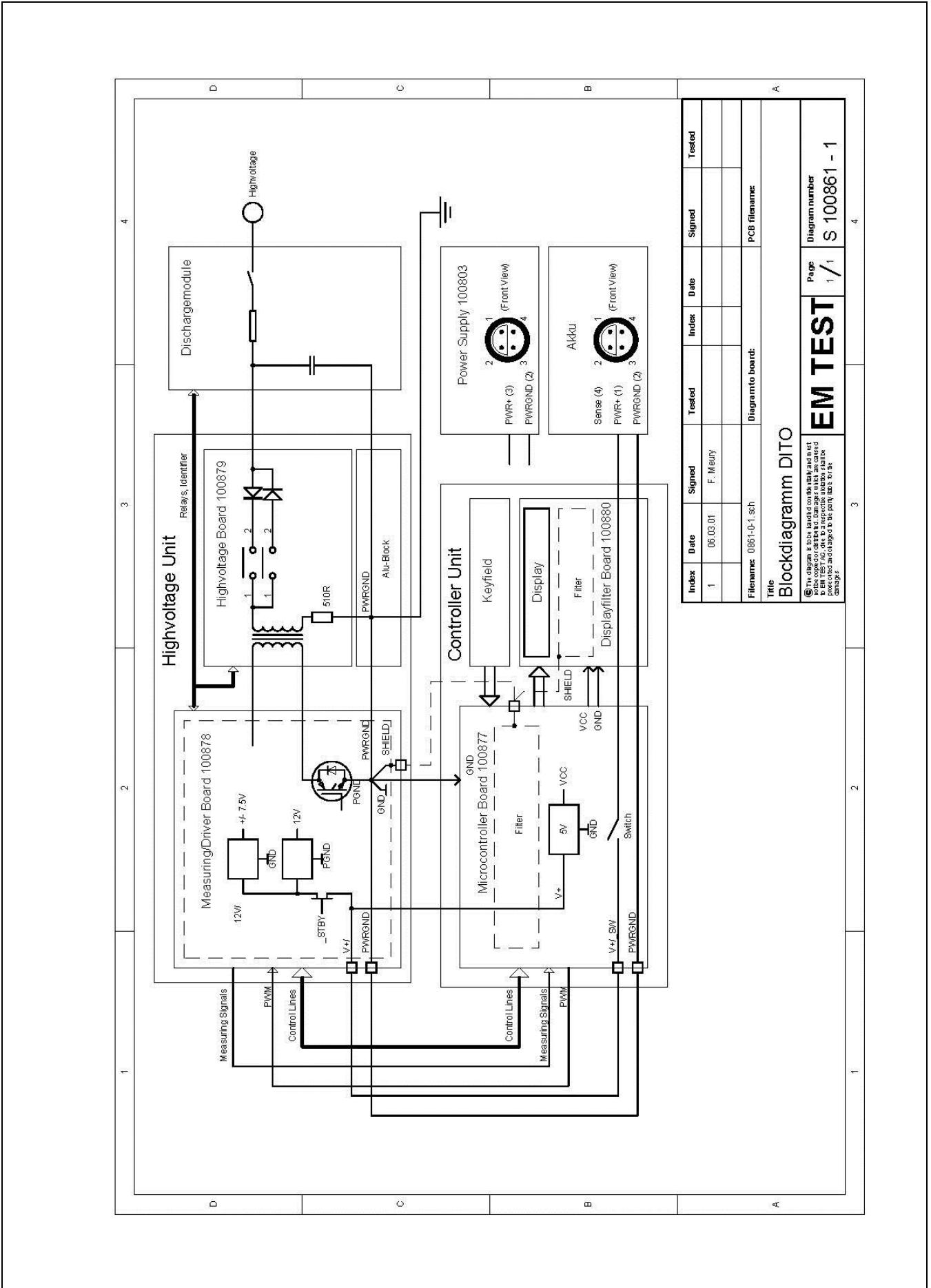

Index	Date	Signed	Indexed	Date	Signed	Tested
1	06.03.01	F. Meury				

Filename: 0861-01_sch
 Diagram to board:

Title	
Blockdiagram DITO	
<small>© The diagram is to be handed on to the manufacturer with the component and damaged units are created by the manufacturer. The manufacturer is not liable for any damage.</small>	

Diagram number	Page
EM TEST	1 / 1
S 100861 - 1	

8.4. Application

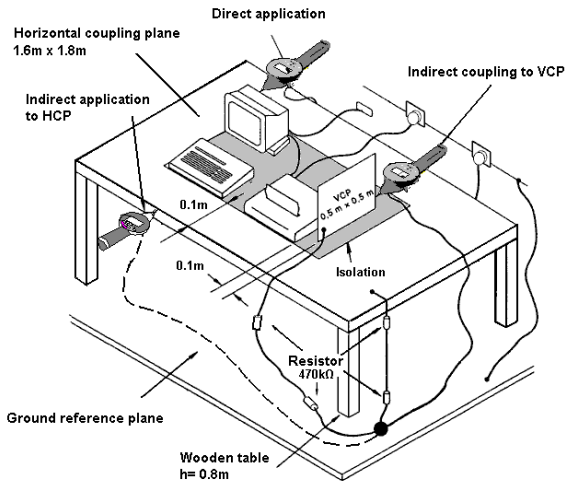

Example of test set-up for table-top equipment, laboratory tests.

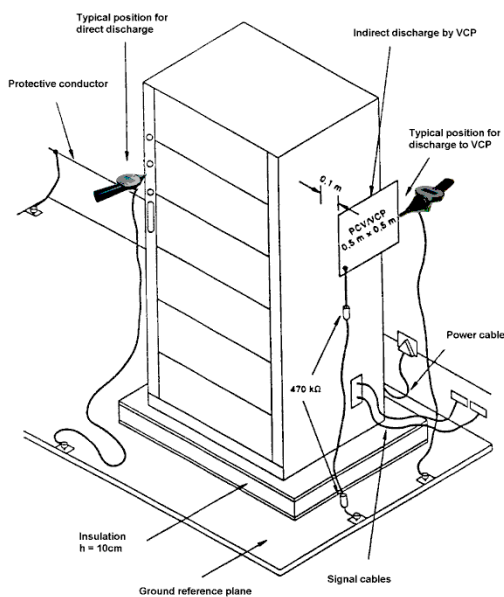

Example of test set-up for floor standing equipment, laboratory tests.

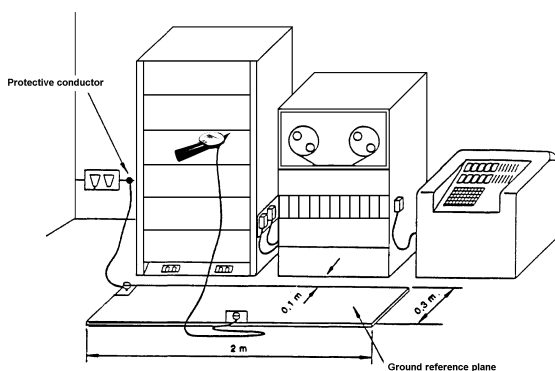

Example of test set-up for floor standing equipment, post installation tests.

Test points per IEC 61000-4-2

Direct discharge

- All accessible points of the surface of the DUT: Cables, housings, displays, keyboards, etc.
- The points which are accessible only for customer maintenance.

Indirect discharge

- VCP at each side of the DUT
- HCP 10 cm distance to the DUT

For additional information concerning the test setup and the test procedure please read the IEC 61000-4-2 carefully.

8.5. Definitions

- **Actual ESD events:** Non-simulated electrostatic discharges that occur in the environment of the electronic equipment.
- **Air discharge method:** A method of ESD testing in which the charged electrode of the ESD simulator approaches the EUT regardless of the conductivity of the surface being subjected to the ESD event. A spark in air to the EUT actuates the discharge.
- **Bleeder wire:** Conductive wire with high impedance, high voltage series resistors to dissipate applied electric charge from HCP, VCP and EUT slowly.
- **Charging current:** The maximum continuous current at any charge voltage that may flow at the ESD simulator probe tip as measured on the return path of the simulator through a 1500- Ω resistor connected to the probe tip.
- **Contact discharge method:** A method of ESD testing in which the electrode of the ESD simulator is in firm electrical contact with a conductive surface of the EUT or coupling plane prior to discharge. A switching device (i.e., a relay) within the simulator actuates the discharge.
- **Controlled ESD environment: One in which an attempt is made to** maintain charge and/or voltage levels on humans and objects below a certain level. Typical control measures include humidity controls, equipment earth grounding, use of anti-static materials, ionized air, and high-resistance discharge paths for humans.
- **Coupling plane:** A metal plate to which discharges are applied to simulate electrostatic discharge to objects adjacent (vertically or horizontally) to the EUT. *See also:* HCP, VCP.
- **Direct ESD test:** A test in which ESD is applied directly to the surface or structure of the EUT.
- **Electrostatic discharge (ESD):** The sudden transfer of charge between bodies of differing electrostatic potentials.
- **ESD event:** The occurrence of a single ESD.
- **ESD simulator:** A testing device used to simulate a human ESD event.
- **ESD target adapter:** Adapter used to connect reference pulse or sinusoidal generators to the ESD target.
- **ESD test voltage:** The amplitude (usually expressed in kV) of the electrostatic voltage that exists prior to discharge.
- **EUT:** Equipment Under Test.
- **Exerciser:** A device used to operate the EUT.
- **Failure:** The inability of a product to meet its operating specification.
- **Fault:** In testing a digital circuit, any difference between the expected and the actual output sequences produced in response to an input sequence. A fault may or may not lead to a failure.
- **Ground reference plane (GRP):** A flat conductive surface whose potential is used as a common reference. Where applicable, the operating voltage of the EUT and the operator ground should also be referenced to the ground plane.
- **Hand/metal ESD:** An ESD from an intruding human hand that occurs from an intervening metal object such as a ring, tool, key, etc. *Also called:* hand/metal discharge.
- **HCP:** Horizontal coupling plane.-